

ATTENTION !!!

Connect to Wi-Fi Network Indoors Prior to Installation

Ensuring your **The MIGRO®** Smart Wi-Fi Controller is functioning prior to field installation is required by the manufacturer. Environmental and application specific conditions may cause communication error and manufacturer. Environmental and application specific conditions may cause communication error and a bench test will ensure that the equipment is functioning properly. Connect a 120VAC Power Supply to the System and perform the pairing steps to ensure connection. (see pairing instructions)



WARNING

- This Smart Box system should be installed by a LICENSED ELECTRICIAN. Turn Power off at main panel before servicing this switch or the equipment it controls.
- Wiring must be in accordance with all national and local electrical code requirements.
- This Smart Box Enclosure does not provide grounding between conduit connectors.

Installation Instructions

Your Wi-Fi control system must be installed and maintained as described in this guide to ensure reliable and safe operation. Confirm the voltage and current draw of your connected load to the control output is consistent with the design specifications of this product and that your application will not exceed the maximum load capacity listed.

Part #: M912050



System Features

Wi-Fi ENABLED CONTROLS

Use mobile apps as well as Google and Alexa to your system on/off or scheduling

MANUAL ON MODE

"Manual ON" mode will give you the ability to run your system regardless of the Wi-Fi control status.

BEYOND SCHEDULING

Use the Google, Alexa and IFTTT capabilities to control your systems by weather, workflow Geo-fencing, and others.

OVERRIDE OFF MODE

This mode provides users with great safety protection. The OFF mode will remain OFF regardless of Wi-Fi controls.

Additional Data:

Power Supply: 110/120VAC

Relay: DPST

Security: WEP/WPA-PSK/WPA2-PSK

FCC Part 15 IEEE 802.11 b/g/n

Wi-Fi Frequency: 2.412-2.48GHz

Contact Load Ratings

- Normally Open
- 50 A. Incandescent or Resistive Load AC1
- 40 A. Ballast and General Purpose AC3
- 5HP @120V, 6 KW 120VAC
- 40 A. Ballast 4.8 KW@ 120VAC

Find other Wireless Control Solutions at www.MIGRO.com as well as compatible accessories

© MIGRO WIRELESS SOLUTIONS 01/2020

MIGRO®

Smart Wi-Fi Controller

ATTENTION !!!

Connect to Wi-Fi Network Indoors Prior to Installation

Installation Instructions

1 CONDUIT FITTING

Install the Conduit Fitting provided (or one provided by others) in the desired location ensuring wire clearance within the enclosure.

2 ANTENNA

Install the Antenna provided on to the threaded connector located on the outside of the enclosure.

3 MOUNT TO DESIRED LOCATION

Place and mount the enclosure to your desired location using the supplied hardware. The brackets are to be mounted to the back exterior of the enclosure with the wall flanges facing out. (See Image 1)

4 WIRE THE SYSTEM

Wire in accordance with the national and local electrical codes (see wiring diagram). After wiring is complete, turn circuit power on and test your MIGRO® Mi-Fi Switch.

Manual Override:

Momentarily press the small BLACK button located on the white Sonoff smart WiFi switch module.

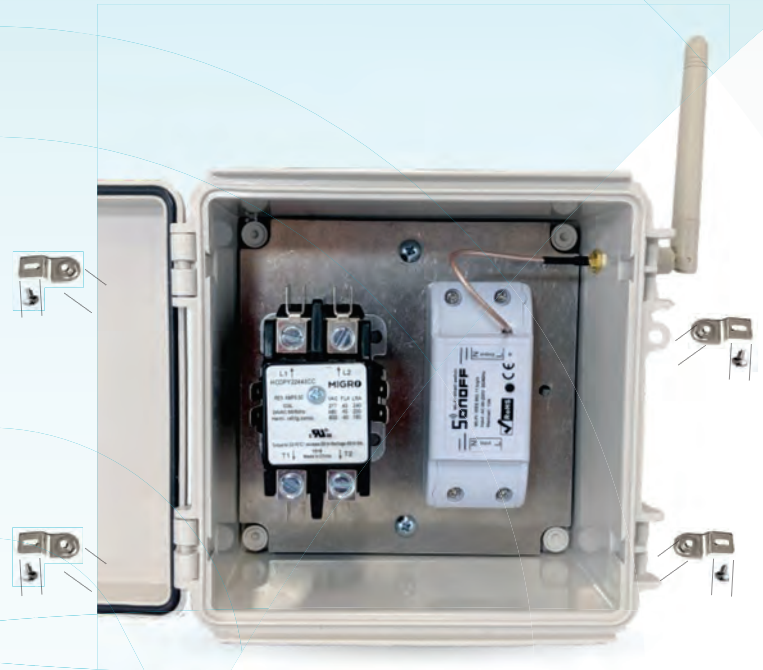

IMAGE 1. Mounting Brackets

WIRING & PAIRING



L = Line
N = Neutral
T = Load Terminal

System Features

Wi-Fi ENABLED CONTROLS
Use mobile apps as well as Google and Alexa to your system on/off or scheduling

BEYOND SCHEDULING
Use the Google, Alexa and IFTTT capabilities to control your systems by weather, workflow Geo-fencing, and others.



PAIRING TO WI-FI NETWORK

To Connect your MIGRO® Smart Wi-Fi Controller to your app and Wi-Fi Network, please refer to the eWelink instructions or Scan the QR Code below.



Scan for INSTRUCTIONS

TIPS

- Install the antenna as high as possible, clear from obstructions or metal structures.
- Ensure that your WiFi Router is placed as high as possible to maximize range and coverage.

Find other Wireless Control Solutions at www.MIGRO.com as well as compatible accessories

© MIGRO WIRELESS SOLUTIONS 01/2020



MIGRO®

Smart Wi-Fi Controller

Sample Applications



Pool/Spa Pumps
Schedule pumps to run daily or weekly



Sprinkler/Irrigation
Run in-line with your timer to override rainy days or weekly



Outdoor Lighting
Schedule and use voice commands on lighting



Water Heaters
Use away setting to turn OFF heaters

Wi-Fi Connection Status

Equipment Status:
Green LED turns ON when equipment is running

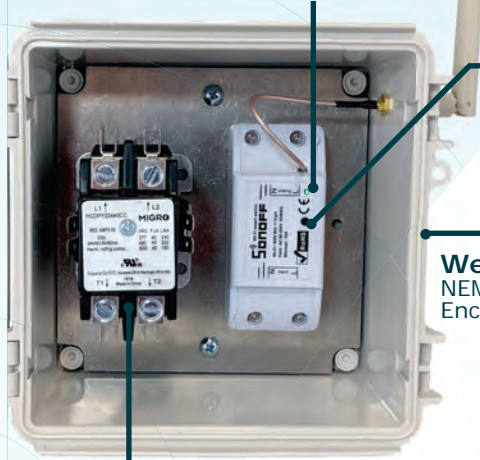







Wi-Fi Pairing
Push button used for initial Wi-Fi Setup & Manual Start/Stop

Weather Proof
NEMA 4 Outdoor Rated Enclosure

50 AMP-2 Pole Contactor
NEMA Rated
110/120VAC Operation

MIGRO® Smart Wi-Fi Controller Compatible System via eWelink

Try connecting your Smart Controller to these Compatible sys

-  Amazon Alexa
-  Google Home
-  Google Nest
-  IFTTT Connections
-  Weather Underground
-  Microsoft Cortana

Sample Use Case Diagram

120VAC Application

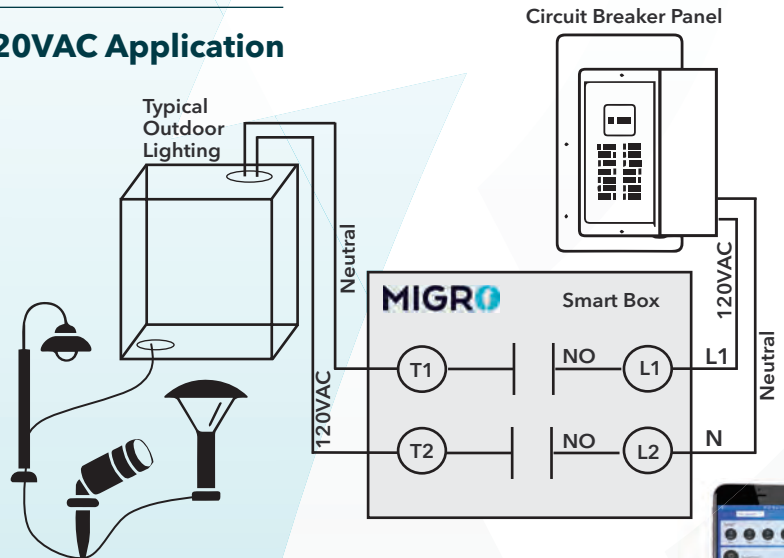

Find other Wireless Control Solutions at www.MIGRO.com as well as compatible accessories

© MIGRO WIRELESS SOLUTIONS 01/2020

